

# USB2.0/3.2/BC1.2 Drop Droop Test for non-USB Type-C™ Products

Version 1.4.1 – 19 June 2018

## Contents

Contents .....	2
1. Equipment .....	3
2. Test hardware.....	4
3. Vbus drop droop requirements.....	6
4. Test procedure .....	7
4.1 Drop Test .....	7
4.1.1 Drop Hub or Host Downstream port multimeter approach.....	7
4.1.2 Drop Hub or Host Downstream port oscilloscope approach .....	9
4.2 Droop Test .....	11
4.2.1 Droop Hub or Host Downstream port.....	11

## 1. Equipment

The equipment required for USB Drop Droop testing is:

- USB 2.0/3.2/BC1.2 Drop Droop Fixture
- Vbus breakout and measurement board
- Double banana plug with shorting bar
- Short USB extension cable (A-plug to A-receptacle)
- 1 meter USB 3.2 cables (Quantity depending number of downstream ports)
- Oscilloscope
- Multimeter (optional)

## 2. Test hardware

The below Drop Drop fixture that can be purchased at [www.testusb.com](http://www.testusb.com) or [www.fixturesolution.com](http://www.fixturesolution.com). The amount of load ports used for testing must be equal to the number of exposed ports on the DUT. For droop testing one droop port is required.

Following loads are available on the drop drop board Fixture:

Seven static drop loads are available that can be set to:

- 100mA
- 150mA
- 500mA
- 900mA
- 1500mA

One dynamic droop load that switches at 1 Hz and can be set to:

- 100mA
- 150mA
- 500mA
- External load (to connect your own load)

All drop and droop loads have 10uF capacitors placed for load purposes. A jumper setting must be made at each load port that is used for testing.

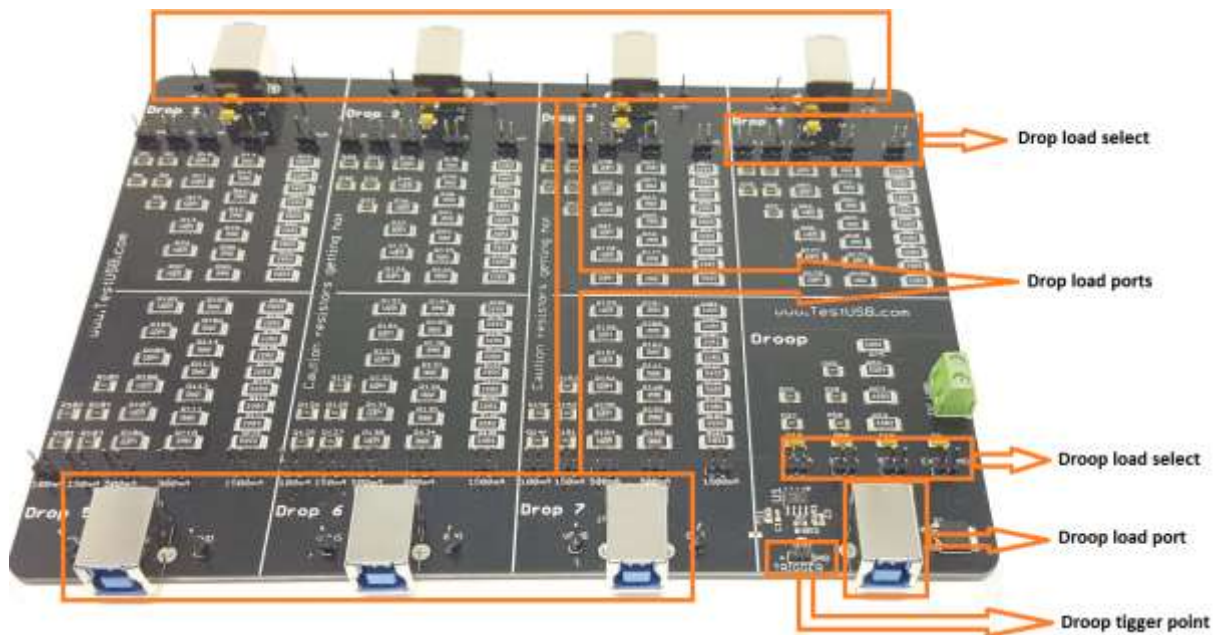

Figure 1: Drop Drop Fixture

Caution: the load resistors of the Drop Drop Fixture will get hot if the loads are turned ON for extended periods of time.

The Vbus voltage measurement should be done as near to the downstream port as possible. Therefore the Vbus breakout and measurement board should be used.

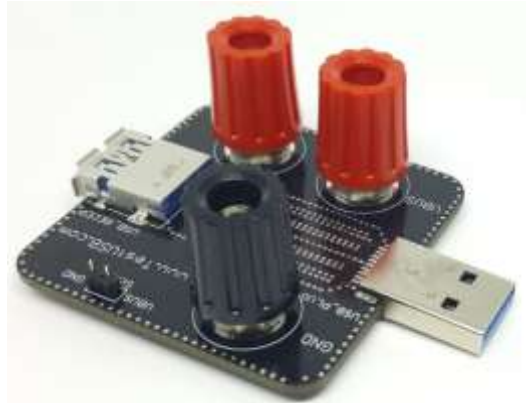

Figure 2: Vbus breakout and measurement board

The Vbus breakout and measurement board has the following features:

- Multimeter measurement capabilities with banana plugs for:
  - Vbus voltage
  - Vbus Current
- Vbus measurement capabilities with oscilloscope probe tips (2.54mm pitch)
- Pass through of USB 3.2 data lines

The Vbus line is discontinued to be able to measure the current that is flowing on the Vbus line. For this reason, for measuring Vbus voltage the double banana plug with shorting bar (Figure 3) should be used.



Figure 3: Double banana plug with shorting bar

The Vbus breakout may prevent to load adjacent ports, therefore it may be required to use a short extension cable (A- plug to A-receptacle) to connect to the Vbus breakout as shown in Figure 4.



Figure 4: Short extension cable

### 3. Vbus drop droop requirements

The requirements are based on the following specification:

Specification	Revision
USB 2.0 Low, Full and High Speed Products	2.0
USB 3.2 Super Speed and Super Speed Plus Products	3.2
USB Battery Charging 1.2 Products (BC 1.2)	1.2

The maximum Vbus voltage for downstream ports with A-receptacle or micro-AB receptacle is as followed:

USB Downstream port under test (non-USB Type-C™)	Load (mA)	Vbus max (V)
All USB downstream ports	All conditions	5.5

Table 1: Maximum Vbus voltage

The minimum Vbus voltage for downstream ports with A-receptacle or micro-AB receptacle is as followed:

USB Downstream port under test (non-USB Type-C™)	Load (mA)	Vbus min (V)
USB 2.0 Bus-Powered hub	100	4.4
USB 2.0 Self-Powered hub	500	4.75
USB 3.2 Self-Powered hub	900	4.75
PC USB 2.0 Host system	500	4.75
PC USB 3.2 Host system	900	4.75
Embedded Host low power (TPL I <sub>max</sub> <100mA)	TPL (*)	4.4
Embedded Host high power (TPL I <sub>max</sub> ≥100mA)	TPL (*)	4.75
Embedded Host USB 3.0	TPL (*)	4.75
BC 1.2 CDP capable hub, host embedded or host port	1500	4.75
BC 1.2 DCP	1500	2

Table 2: Minimum Vbus voltage

(\*) The maximum load is depending on the Target Peripheral List (TPL) of the embedded host

The droop load is depending on the

USB Droop load adjacent to port under test	Droop Load (mA)	Vbus droop max (mV)
USB 2.0 Port	100	330
USB 3.2 Port	150	330
USB BC 1.2 Port	500	330

Table 3: Droop load

## 4. Test procedure

### 4.1 Drop Test

The Drop Test determines whether or not a port can provide the Vbus required voltage levels on all ports when the ports are non-loaded and fully loaded. Table 1 and Table 2 provides the voltage limits for USB 2.0, 3.2 and Battery Charging 1.2 ports in loaded and non-loaded configurations.

A system with USB 2.0, 3.2 or BC 1.2 ports must be tested with all ports loaded simultaneously to the appropriate levels. For end-product hosts/hubs the power supply used during the testing should be the same as that which will be provided to consumers in the market if applicable.

Note: The cumulative load produced on the USB ports should not exceed 5A when testing non-USB Type-C™ products. Hence when testing it may not be necessary to load all ports if the sum of all currents is greater than 5 A. If a host has more than 5 USB 3.2 ports it is necessary to adjust the loads in order to draw close to 5A.

Example: Loading 4 ports to USB 3.2 levels and 2 ports to USB 2.0 levels will draw a total of 4.6A. An additional Low-Power load must be added to the total to account for the unconfigured current draw of the droop port, resulting in either 4.7A or 4.75A total load. This is as close as possible to the 5A maximum this fixture can provide while still fully loading many of the 3.2 ports.

#### 4.1.1 Drop Hub or Host Downstream port multimeter approach

##### 4.1.1.1 Equipment Used

Quantity	Item	Description/ Model
1	Multimeter	DC Voltmeter to measure between Vbus and GND
1	Drop Droop fixture	Use the drop ports to load the downstream ports under test
1	Vbus breakout and measurement board	To measure Vbus near to the downstream port
	1m USB Cables	Quantity of USB cables depend on the ports accessible. Use cable with low Vbus resistance.
1	Short extension cable	The Vbus breakout may prevent to load adjacent ports and therefore it may be required to use a short A plug to A receptacle cable to connect to the Vbus breakout.
1	Double banana plug with shorting bar	To short the Vbus on the Vbus breakout and measurement board.

##### 4.1.1.2 Drop test procedure for unloaded setup with multimeter

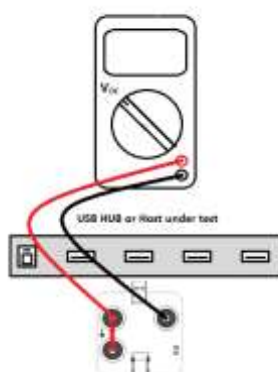

Measure the unloaded voltage of each port under test at the Vbus breakout and check the voltage level against that of the unloaded values in Table 1 and Table 2. If the voltage level is beyond the table limits the host or hub fails the test.

#### 4.1.1.3 Drop test procedure for fully loaded setup with multimeter

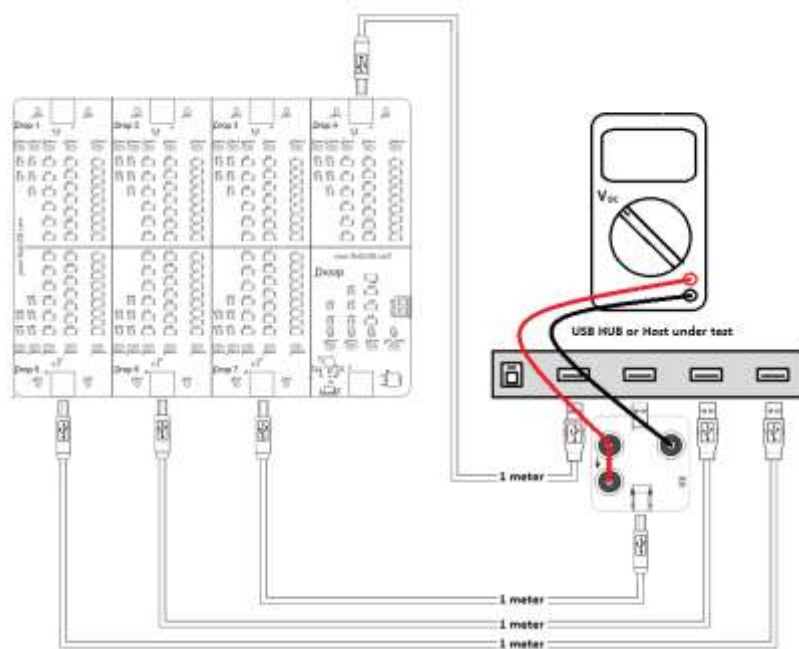

Attach all host or hub ports to drop load ports. Set the correct load setting by placing the jumper at each drop port (see Table 2). Short the Vbus with the double banana plug with shorting bar and measure the loaded voltage of each port under test at the Vbus breakout and check the value against that of the loaded value in Table 1 and Table 2. If the voltage is beyond the table limits the Host or Hub fails the test.



## 4.1.2 Drop Hub or Host Downstream port oscilloscope approach

### 4.1.2.1 Equipment Used

Quantity	Item	Description/ Model
1	Oscilloscope	Oscilloscope with two probes
1	Drop Droop fixture	Use the drop ports to load the downstream ports under test
1	Vbus breakout and measurement board	To measure Vbus near to the downstream port
	1m USB Cables	Quantity of USB cables depend on the ports accessible. Use cable with low Vbus resistance.
1	Short extension cable	The Vbus breakout may prevent to load adjacent ports and therefore it may be required to use a short A plug to A receptacle cable to connect to the Vbus breakout.
1	Double banana plug with shorting bar	To short the Vbus on the Vbus breakout and measurement board.

### 4.1.2.2 Drop test procedure for unloaded setup with oscilloscope

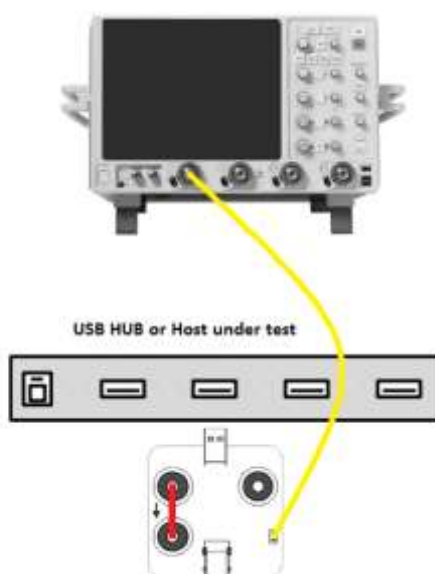

Measure the unloaded voltage of each port under test at the Vbus breakout and check the value against that of the unloaded value in Table 1 and Table 2. If the voltage is beyond the table limits the host or hub fails the test.

#### 4.1.2.3 Drop test procedure for fully loaded setup with oscilloscope

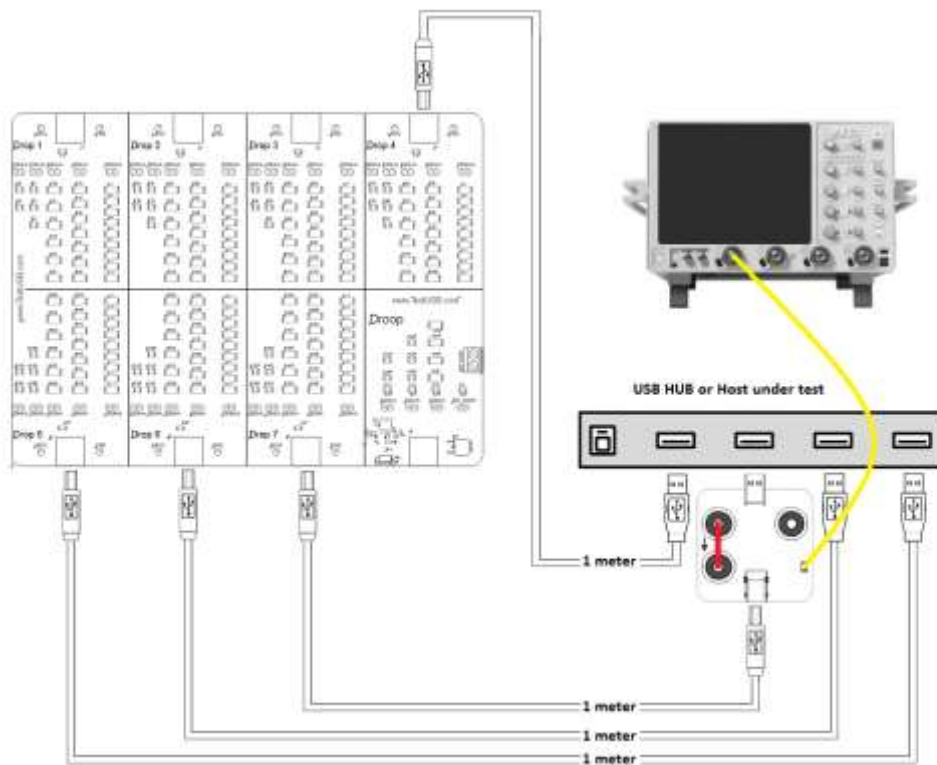

Attach all host or hub ports to drop load ports. Set the correct load setting by placing the jumper at each drop port (see Table 2). Short the Vbus with the double banana plug with shorting bar and measure the loaded voltage of each port under test at the Vbus breakout and check the value against that of the loaded value in Table 1 and Table 2. If the voltage is beyond the table limits the Host or Hub fails the test.

## 4.2 Droop Test

The Droop test measures the amount of voltage droop that a loaded port produces on its Vbus line when a device is connected or resumed from an adjacent port. USB 2.0, USB 3.2 and BC1.2 specify a maximum droop voltage of 330mV. The Droop test is only applicable for hub or host with more than one accessible downstream port.

### 4.2.1 Droop Hub or Host Downstream port

#### 4.2.1.1 Equipment Used

Quantity	Item	Description/ Model
1	Oscilloscope	Oscilloscope with two probes
1	Drop Droop fixture	Use the drop ports to load the downstream ports under test
1	Vbus breakout and measurement board	To measure Vbus near to the downstream port
	1m USB Cables	Quantity of USB cables depend on the ports accessible. Use cable with low Vbus resistance.
1	Short extension cable	The Vbus breakout may prevent to load adjacent ports and therefore it may be required to use a short A plug to A receptacle cable to connect to the Vbus breakout.
1	Double banana plug with shorting bar	To short the Vbus on the Vbus breakout and measurement board.

#### 4.2.1.2 Droop test procedure

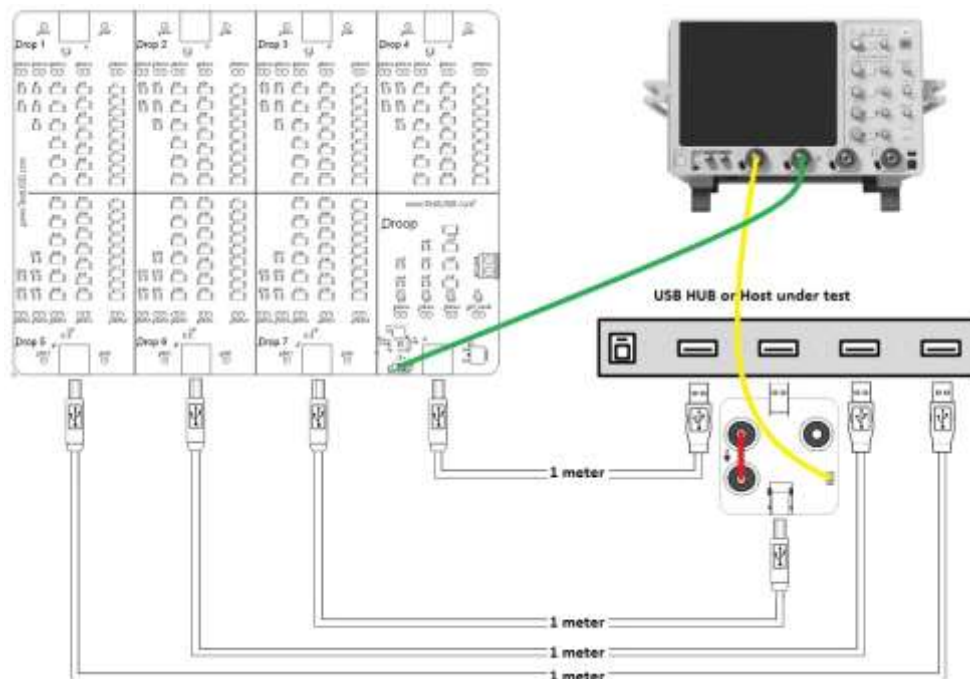

Attach to one host or hub port the droop load (see Table 3). Set the correct droop load setting by placing the jumper. All the remaining host or hub ports should be connected to the drop loads. Set the correct load setting by placing the jumper at each drop port (see Table 2). The most droop effect is typical seen when connecting the droop load nearest to the port under test. Therefore connect the droop load adjacent to Vbus breakout of the measurement port.

Connect Channel 1 probe to the Vbus breakout. Make sure the double banana plug with shorting bar and appropriate drop load are connected to the Vbus breakout. Connect Channel 2 probe to trigger of the Drop Droop fixture.

Following oscilloscope should be set:

- Set Channel 1 to 100mV/div (offset 4.5V)
- Set Channel 2 to 2V/div
- Set Timebase to 20uS/div
- Set Trigger to “normal” and “falling edge” for Channel 2 (1.5V)
- Set Acquisition Mode to High Resolution. If oscilloscope not have High Resolution mode use Average(16)

The result may look as followed:



Using the oscilloscope cursors measure the difference from Channel 1 voltage level before the trigger to the lowest droop point. If this value exceeds 330mV the test fails.